

# MAXBrite®

## High Power Sign Module

POLAR  Series

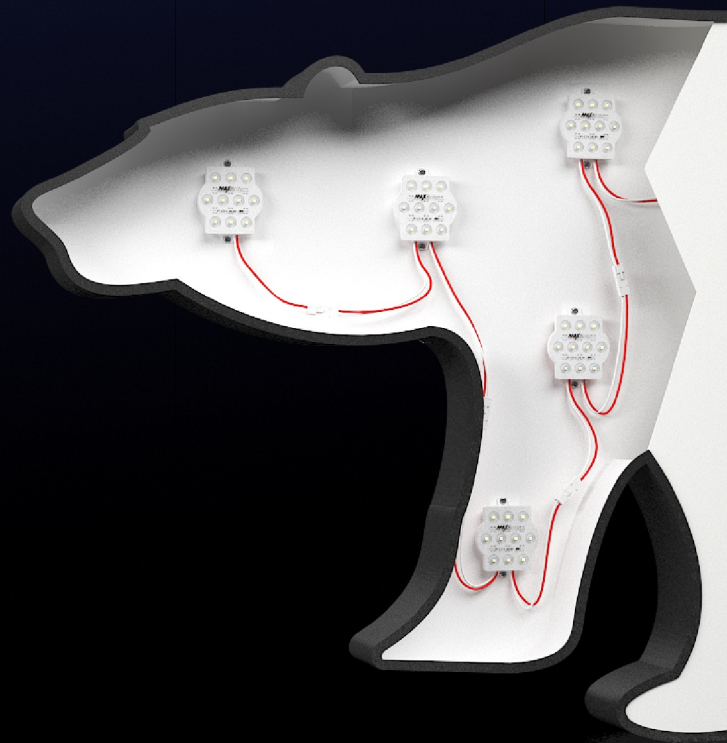

### 950 Lumens Per Module

- Constant Current Technology
- Easy Plug-n-Play with Molex Connector
- Versatile Lighting for a Variety of Applications
- Illuminates Evenly for Uniform Light Distribution
- Super Wide Pitch with No Hot Spots
- 180° Wide Angle Optical Lens

c  US

IP67

CE

FC

 RoHS

 5 YEAR WARRANTY

# MAXBrite®

## Specifications:

Power Consumption	10W Constant Current
Input Voltage	12V DC
CCT	7,000K
Luminous Flux	950 lm
CRI	>80
Light Source	Epistar 2835 (1W per diode)
Viewing Angle	180°
Operating Temp.	-20° to +158°F
LED Quantity	10 LEDs
LED Lifespan	50,000 hours
IP Rating*	IP67
Wire Connector	16 AWG (pre-attached Molex Connectors)
Housing	Molded ABS
Lens	Panlite Polycarbonate

\*IP rated for dry, damp, and wet locations. Not for marine/submerged or direct to rain or snow installations.

## Dimensions:

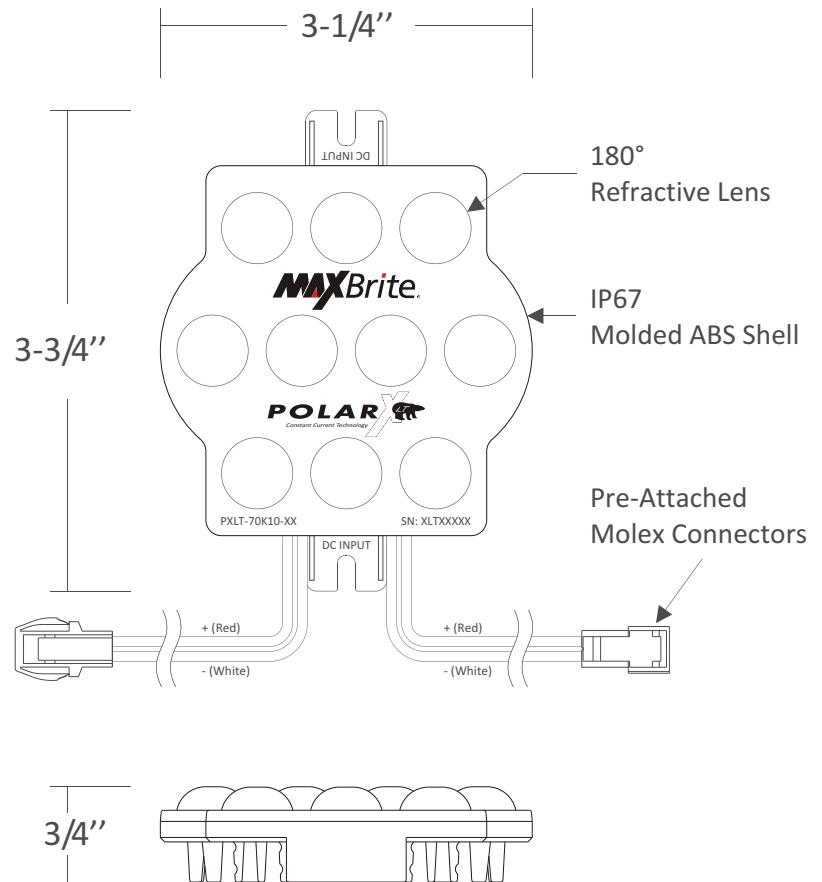

## MOUNTING METHODS:

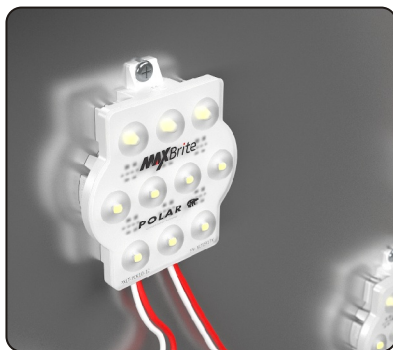

Use the pre-applied tape to temporarily mount modules to the back of your cabinet, then mechanically secure together.

OR

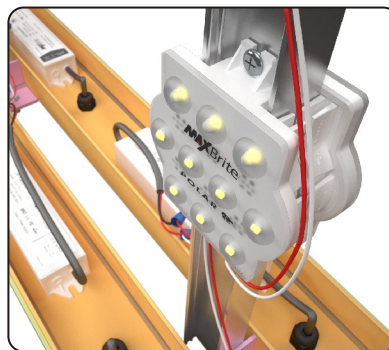

Snap module onto our Polar Extrusion, then fasten with self tapping screws for extra starnhth.

&

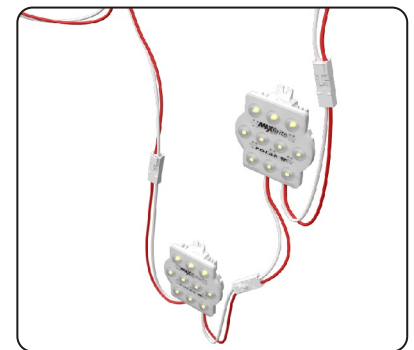

"Daisy-chain" multiple modules together with their pre-attached Molex connectors.

# MAXBrite

## Wiring Diagram:

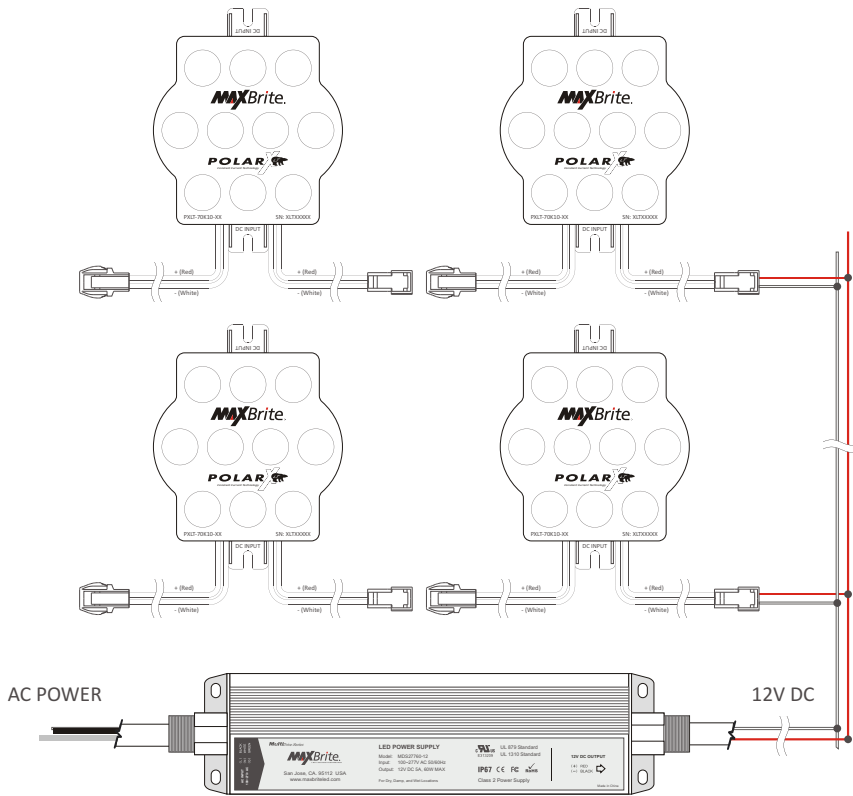

Maximum driver quantity per serial connection is limited. Using more quantity per run will cause overload on Power Supply which damages all connected products. This will cause voltage drop and dimmed lighting output.

## Power Supply Loading:

Output (W)	20W	30W	40W	45W	60W
Max. Quantity Of Modules*	1	2	3	3	4
Max. Recommended Extension Wire Length	15 ft 18AWG	30 ft 18AWG	50 ft 16AWG	75 ft 14AWG	100 ft 12AWG

\* Maximum quantity for MAXBRITE POLAR XLT is based on approximately 75% of specified capacity of power supplies for extended lifespan. Equip with protective box for outdoor use and the box should have ventilating holes.

## CAUTIONS

- ⚠ USE 12V DC CONSTANT VOLTAGE INPUT ONLY
- ⚠ DO NOT USE AC INPUT!
- ⚠ Do not cut or rejoin wires while product is connected with live power source.
- ⊘ DO NOT PERFORM ACTION LISTED BELOW
  - ◆ Alter or modify Modules
  - ◆ Touch LED lamps with sharp objects
  - ◆ Put glue or silicone over the LED lamps
- ⊘ Not for marine/submerged installations
- ⊘ Avoid performing installation under rain or high humidity and only install in temperatures above 50°F (10°) to allow for better mounting tape adhesion
- ⚠ Maximum driver quantity per serial connection is limited to available power supply wattage, failure causes overload of current and damages to the product

## Recommended Layout Density:

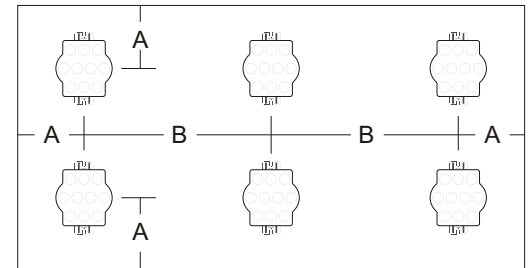

Distance "A"  
6-7" Recommended  
9" Maximum

Distance "B"  
12-14" Recommended  
18" Maximum



Use recommended length for pitch between each module to achieve optimum lighting output while maintaining lowest unit cost. Failure or misplacing will cause dimmed spots or uneven appearance of light on the surface. 6" minimum depth.

# Product Limited Warranty

MaxBrite LED is dedicated to providing defect-free products that will give the buyer years of trouble free operation. These products offer high design standards and are the most thoroughly tested in the industry. All MaxBrite LED products maintain very strict quality assurance standards that are essential to customer requirements.

MaxBrite LED warrants its LED products and Power Supply products to meet the performance criteria outlined in the written data sheets and specifications. These products are guaranteed to be free from defects in materials and workmanship for the warranty period stated below, as long as the MaxBrite LED products and Power Supplies are used together as a system. If any LED product or Power Supply fails to perform, as specified during the warranty period in accordance with the terms and conditions set forth herein, MaxBrite LED will replace, or at its discretion, repair free of charge, the non-performing product on a pro-rata basis.

## Terms and Conditions

### Usage

This limited warranty is based on reasonable indoor or outdoor usage in architectural applications for image identification, when installed and used in accordance with instructions from MaxBrite LED. Normal operating conditions are defined as 24 hour per day, 7 day per week continuous use in typical outdoor heat and humidity environmental conditions. All LED systems, to varying degrees, have some amount of light degradation over the life of the product. MaxBrite LED designs all of its LED systems to minimize this light degradation but considers this a normal part of LED technology. This limited warranty is valid only when the LED products and Power Supplies are used together for their intended use and properly installed and wired in accordance with all instructions, building codes, the latest Underwriter Laboratory Standards of Safety, National Electric Code, Canadian Standards Association, and all other domestic and international safety agencies that are recognized as having applicable safety requirements. Any use outside intended use or conditions or the conditions stated in MaxBrite LED written data sheets and instruction, or stated herein, including the use of third party dimming, flashing or other effect devices, extreme environmental conditions or any other unintended usage will void this warranty. Replacement of MaxBrite LED products or Power Supplies with any other manufacturer's components will further void this warranty. After the first 36 months, the warranty is held on a pro-rata basis. The pro-rata formula is as follows:  $\frac{P \times T}{W}$

Where P = Current price, T = Remaining term in months, W = The original warranty period in months.

#### Examples:

An approved warranty claim is made within 36 months of purchase, with an original purchase price of \$100, and a 5 year warranty.

MaxBrite is responsible for 100% of the replacement cost since it is within 36 months of purchase.

If the same warranty claim is made with just 48 months remaining on the warranty, MaxBrite LED is responsible for  $\frac{100 \times 48}{60} = \$80$ , and the buyer is responsible for the remaining \$20 for the replacement.

The "date of purchase" refers to the date on your sales invoice. If you cannot find your sales invoice, the date will be calculated based on the date of manufacture which is determined by your product's serial number.

### Warranty Claim Assistance

Should a MaxBrite LED product fail under this warranty please contact MaxBrite LED for a Return Material Authorization number (RMA). An RMA number may be obtained by calling customer service at (408) 437-1600. Information and troubleshooting assistance is also available at this number. Once an RMA number is obtained, the product should be returned directly to MaxBrite LED or the location designated at the time the RMA was issued. Product must be returned within 15 days of RMA issuance for the RMA to remain valid. Please mark all shipping boxes and packing slips with the RMA number. MaxBrite LED, at its sole discretion, may elect to provide replacement product prior to receipt of defective material. If such product is provided, user agrees to return to MaxBrite LED the defective product within 30 days of receipt of replacement. The Customer/Purchaser is responsible for all return shipping costs. Shipping costs are non-refundable. All returned merchandise must be sent back prepaid; we will not accept CODs. Please insure the package(s) for the full amount of the merchandise you are sending back to us. MaxBrite LED is not responsible for missing packages or missing items. Defective product is to be returned to the address listed as the return address on the shipping container. Failure to return defective product within specified time will result in user being charged for replacement product and will void all further warranty claims. Should circumstances arise that preclude the remedying of warranted defects by repair or replacement, MaxBrite LED shall, at its discretion and upon receipt and verification of defective product, refund to the buyer the purchase price or portion of purchase price theretofore paid to MaxBrite LED.

### Limitation of Liability

High quality lighting products is the commitment of MaxBrite LED. By returning defective products it will help us monitor and further improve our product quality. Repair or replacement of product is the sole remedy available. UNDER NO CIRCUMSTANCE SHALL MAXBRITE LED BE LIABLE FOR ANY INCIDENTAL OR CONSEQUENTIAL LOSS OR DAMAGE WHATSOEVER ARISING OUT OF, OR IN ANY WAY RELATED TO ANY DEFECT IN OR NON PERFORMANCE OF THE PRODUCTS. NO WARRANTY OF MERCHANTABILITY OR FITNESS FOR A PARTICULAR PURPOSE IS MADE OR IMPLIED. Furthermore, MaxBrite LED shall not be responsible for any other costs, including installation or field support labor or loss of profits, income or revenue. Additionally, any drawing, layout, quotation or other communication regarding suggested product type, amount or usage is for reference only and should be treated as an estimate. MaxBrite LED shall not be responsible for minimum illumination levels or other performance criteria. MaxBrite LED reserves the right to test and examine all products returned under this warranty to evaluate proper usage, determine the cause of failure, and make a determination, in its sole judgment whether the products are defective and covered by this warranty.